

# AVK Butterfly valves series 756

## How-to-order for DN 150-1200

Revision 2020-02-26

1

### Valve with gearbox [IP 67] and hand wheel

Standard epoxy/epoxy PN 10/16 butterfly valves including gearbox and handwheel for installation in chamber please order:

#### Integral seat

756 - xxxx - 104, for DN 200-1200 - PN 10

756 - xxxx - 114, for DN 150-1200 - PN16

xxxx for dimensions DN 200 – 1200 PN10/16

#### Stainless steel seat

756 - xxxx – 10400009 DN 200-1200 - PN 10

756 - xxxx – 11400009 DN 200-1200 - PN 16

xxxx for dimensions DN 200 – 1200 PN10/16

Valve size	Handwheel max. closing torque(Nm)	Turns to open rev.	Free running torque (Nm)	Min. strength torque (Nm) (EN1074)
DN150	15	8,5	7	30
DN200	40	8,5	7	80
DN250	50	8,5	7	100
DN300	*70/**75	*8,5/**9,5	7	*140/**150
DN350	*80/**85	*8,5/**9,5	7	*160/**170
DN400	*80/**90	9,5	7	*160/**180
DN450	85	*9,5/**14	7	170
DN500	*95/**105	*9,5/**14	7	*190/**210
DN600	*140/**105	*14/**27	7	*280/**210
DN700	*115/**85	*27/**54	12	*230/**170
DN800	*135/**100	*27/**54	12	*270/**200
DN900	100	*54**82	12	200
DN1000	*100/**120	*61/**82	12	*100/**240
DN1200	*115/**90	*82/**182	12	*230/**180

\*PN10/\*\*PN16

All items marked with solid black in below illustration are included in the above configuration

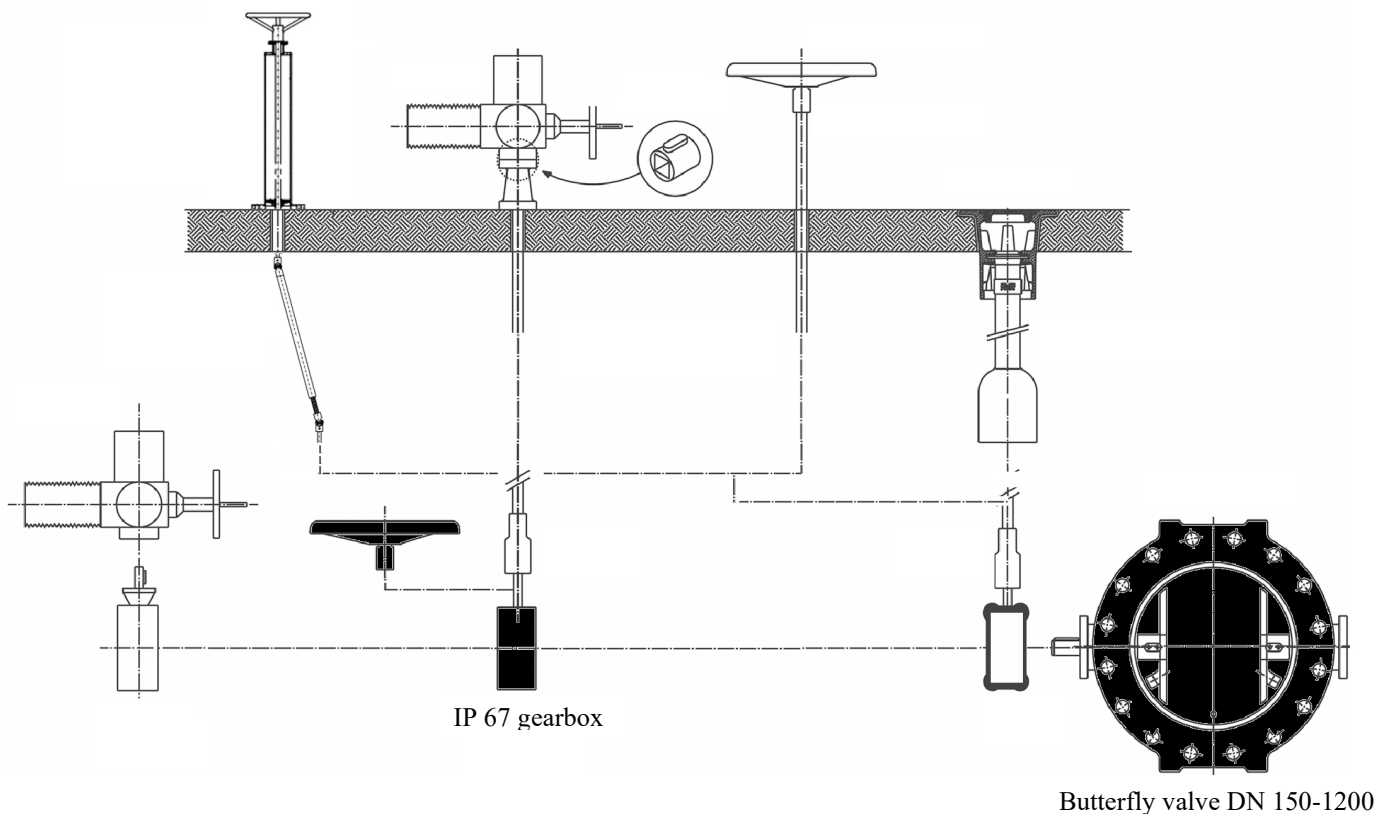

**Valve with gearbox [IP 68], extension and street cover**

Standard epoxy/epoxy PN 10/16 butterfly valve including gearbox IP 68, AVK telescopic extension spindle and universal street cover. For installation directly in the ground without chamber, please order:

**Integral seat**

756 - xxxx - 104006, for DN 200-1200 – PN10  
 756 - xxxx - 114006, for DN 150-1200 – PN16  
 xxxx for dimensions 0200 - 1200 mm

**Stainless steel seat**

756 - xxxx - 10400609, DN 200-1200 - PN10  
 756 - xxxx - 11400609, DN 150-1200 – PN16  
 xxxx for dimensions 0200 - 1200 mm

**Extension spindle:**

04 - xxx - 90002, length 450 - 700, for valves DN xxx  
 04 - xxx - 90502, length 650 - 1100, for valves DN xxx  
 04 - xxx - 91002, length 1050 - 1750, for valves DN xxx  
 04 - xxx - 91502, length 1700 - 2900, for valves DN xxx  
 xxx = "400" for DN 150– 500 PN10/16, DN600 PN10  
 xxx = "600" for DN600 PN16, DN700-1200 PN10/16

**Street cover:**

04 - 003 - 6900, street cover with lid.  
 80 - 46 - 00001, plastic support tile.  
 04 - 001 - 0200, plastic fixations plugs for support plate to connect with universal street cover.

**Optional: Loose handwheel with adaptor (KIT) for connection with IP 68 gearbox in chamber:**

08-200-1100001: Ø360mm CTC, DN150-500 PN10/16 and DN600 PN10. Butterfly IP 68 gearbox.  
 08-400-1100001: Ø600mm CTC, DN600 PN16. Butterfly IP 68 gearbox  
 DN 700-1200: Always including Ø700 mm handwheel

-----  
 All items marked with solid black in below illustration are included in the above configuration.

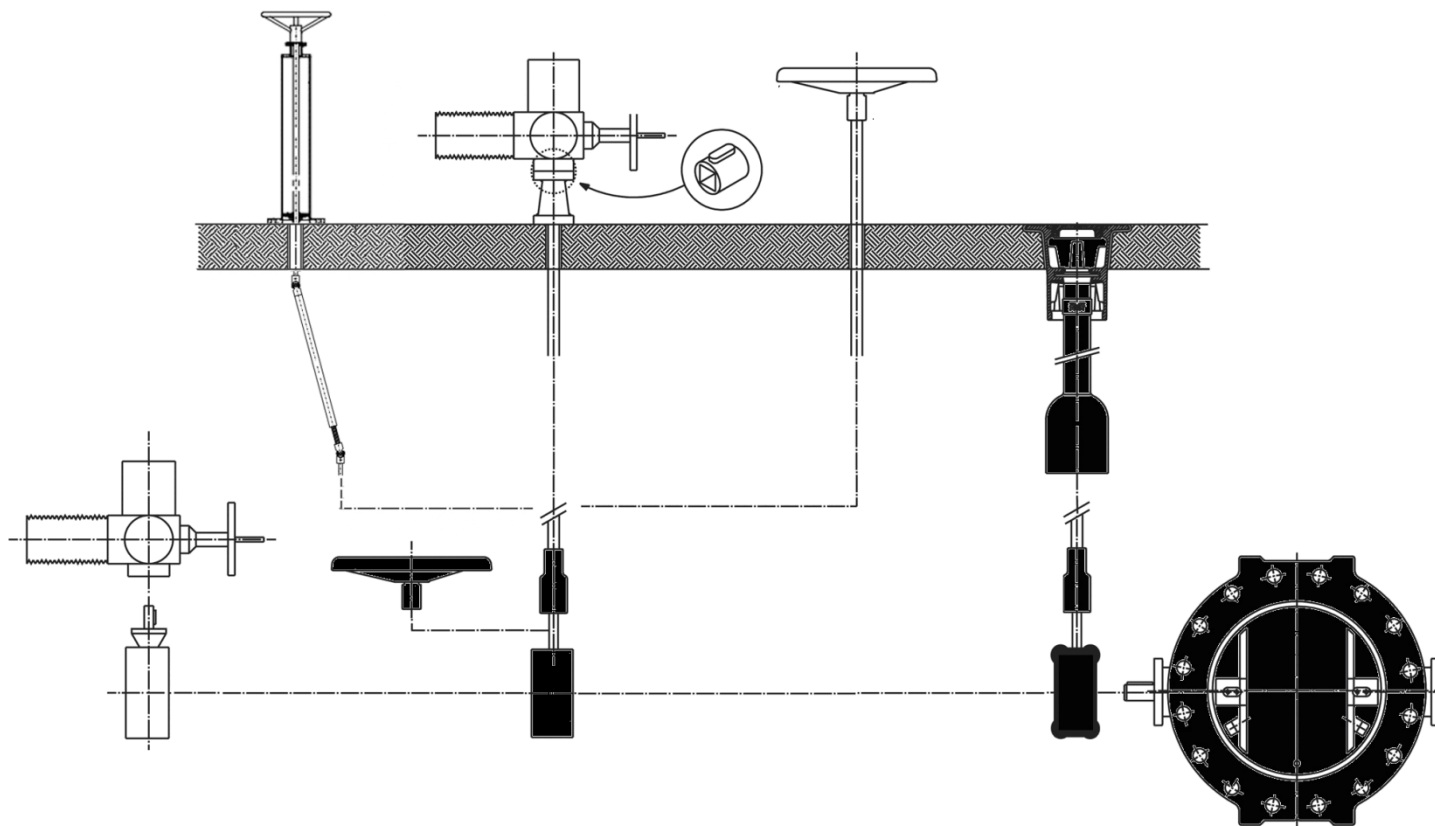

Butterfly valve DN 150-1200

**Valve with gearbox [IP67 or IP68], extension bar #25mm and handwheel**

Standard epoxy/epoxy PN 10/16 butterfly valve including gearbox and handwheel, extension carried out with steel bar #25 mm supplied by customer. For installation in chamber and operated by handwheel above ground, please order:

**Integral seat / gear IP67**

756 - xxxx - 104, for DN 200-1200 - PN 10  
 756 - xxxx - 114, for DN 150-1200 - PN16

**Stainless steel seat / gear IP 67**

756 - xxxx - 10400009 DN 200-1200 - PN 10  
 756 - xxxx - 11400009 DN 150-1200 - PN 16

**Integral seat / gear IP 68**

756 - xxxx - 104006, DN 200-1200 - PN10  
 756 - xxxx - 114006, DN 150-1200 - PN16

**Stainless steel seat / gear IP 68**

756 - xxxx - 10400609, DN 200-1200 - PN10  
 756 - xxxx - 11400609, DN 150-1200 - PN16

**Adaptor for gearbox to #25 mm:**

756-0400-2800: For DN 150 – 1200 PN10/16 mounted to standard IP67 gearbox or IP68 gearbox.

**Galvanized rod #25 mm:**

To be cold drawn steel grade 37, or grade 52. Supplied by customer, not by AVK.

**Adaptor for handwheel:**

756 - 0600 - 4800, for connecting handwheel to galvanized rod and handwheel.

**Cast handwheel:**

08-200-110000: Handwheel, Ø360 (incl. A2 Hex bolt and washer) for DN 150 - 500 CTC PN10/16, DN600 PN10  
 08-400-110000: Handwheel, Ø640 (incl. A2 Hex bolt and washer) for DN 600 PN16, DN700 - 1200 CTC PN10/16

-----  
 All items marked with solid black in below illustration are included in the above configuration

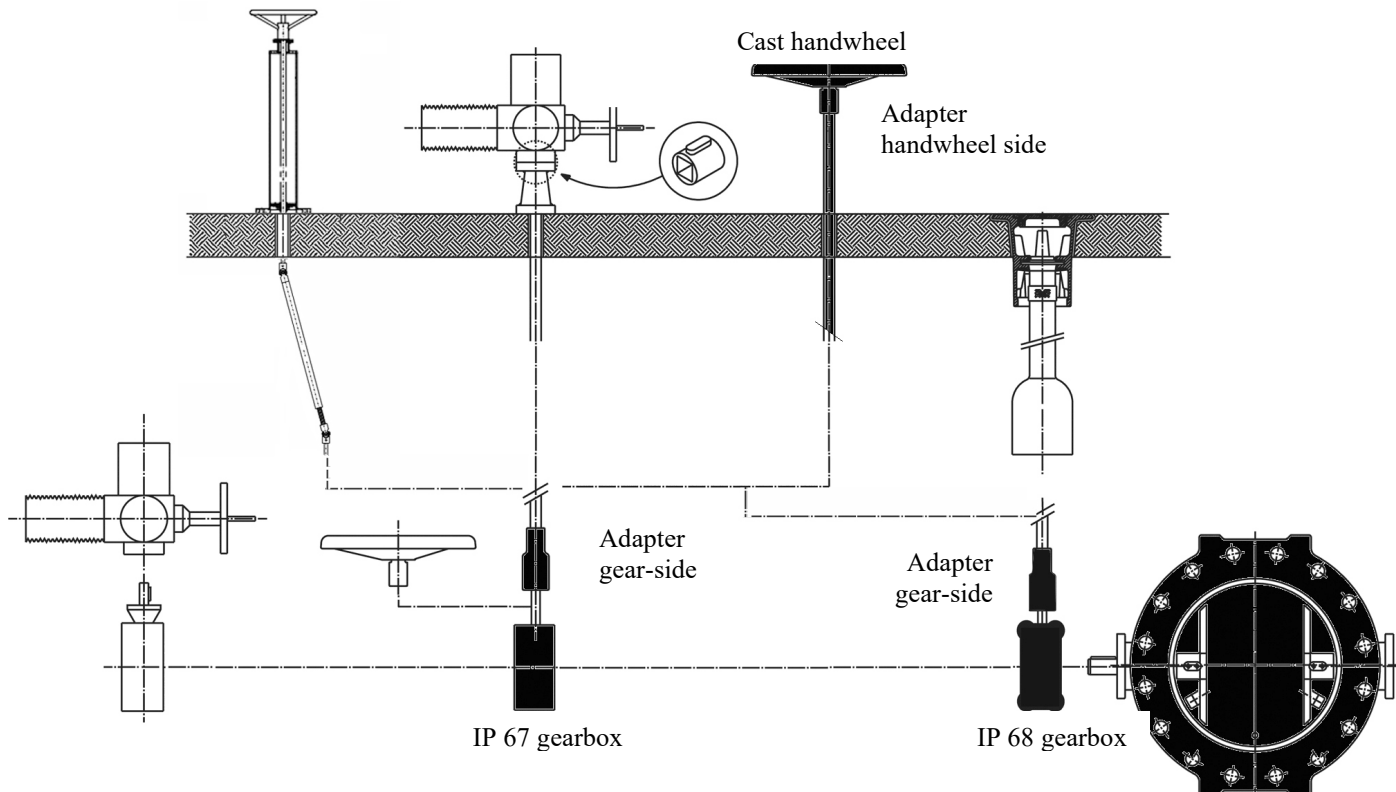

Butterfly valve DN 150-1200

**Valve with gearbox [IP67 or IP68], with T-key operation #30mm – AVK France execution**

Standard epoxy/epoxy PN 10/16 butterfly valve including gearbox and handwheel, extension carried out with steel bar #25 mm supplied by customer. For installation in chamber and operated by handwheel above ground, please order:

**Integral seat / gear IP67**

756 - xxxx - 104, for DN 200-1200 - PN 10  
 756 - xxxx - 114, for DN 150-1200 - PN16

**Stainless steel seat / gear IP 67**

756 - xxxx - 10400009 DN 200-1200 - PN 10  
 756 - xxxx - 11400009 DN 150-1200 - PN 16

**Integral seat / gear IP 68**

756 - xxxx - 104006, for DN 200-1200 – PN10  
 756 - xxxx - 114006, for DN 150-1200 – PN16

**Stainless steel seat / gear IP 68**

756 - xxxx - 10400609, for DN 200-1200 – PN10  
 756 - xxxx - 11400609, for DN 150-1200 – PN16

**Adaptor for gearbox to #30 mm, for T-key operation:**

756-0400-5800: Stem cap, # 30mm outside  
 For DN 150 – 1200 PN10/16 mounted to standard IP67 gearbox or to IP68 gearbox.

**T-key:**

To be purchased locally

All items marked with solid black in below illustration are included in the above configuration

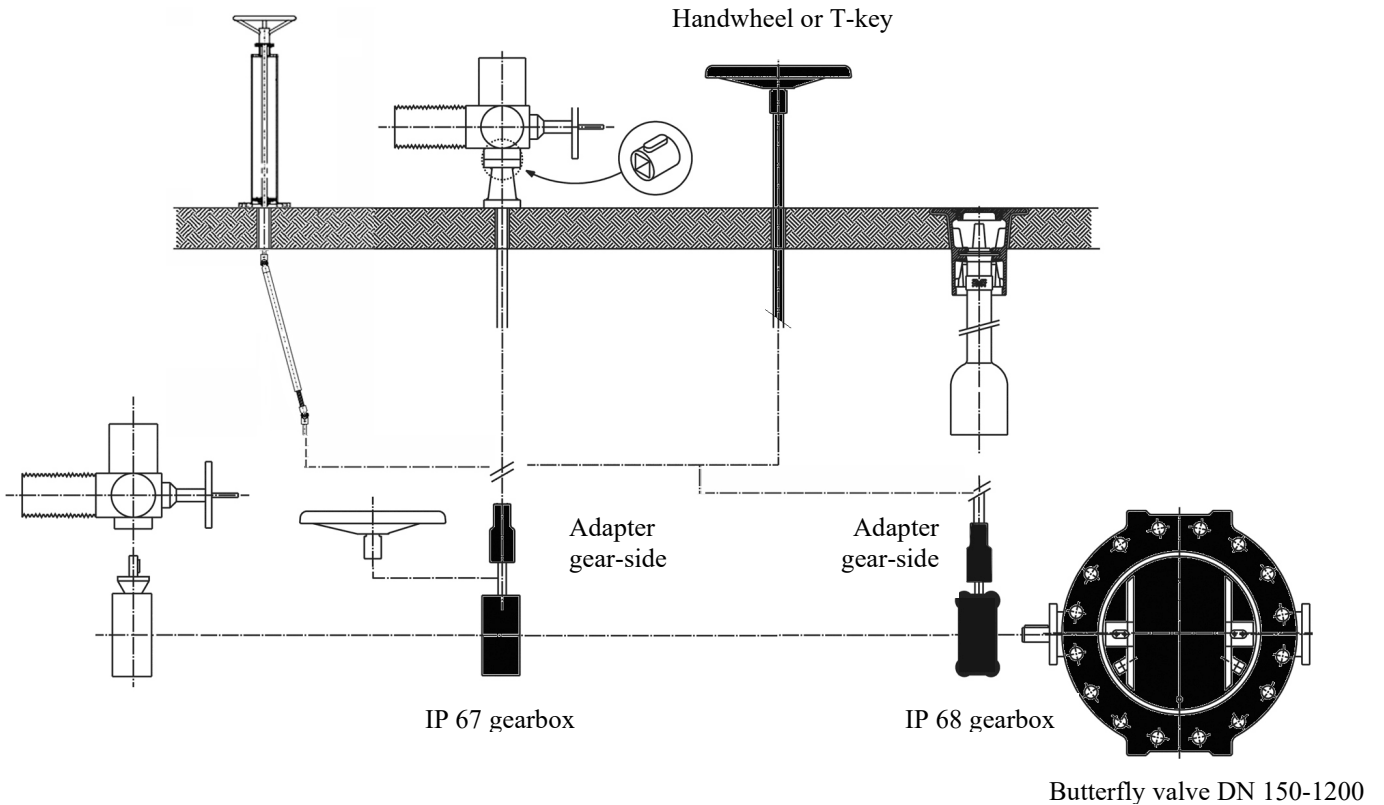

**Valve with gearbox [IP 67 or IP 68], extension bar #25mm and electric actuator**

Standard epox/epox PN 10/16 butterfly valve including gearbox, extension carried out with steel bar #25 mm supplied by customer and operated by electric actuator. For installation in chamber and operated by actuator above ground, please order:

**Integral seat / gear IP67**

756 - xxxx - 104, for DN 200-1200 - PN 10  
 756 - xxxx - 114, for DN 150-1200 - PN16

**Stainless steel seat / gear IP 67**

756 - xxxx - 10400009 for DN 200-1200 - PN 10  
 756 - xxxx - 11400009 for DN 150-1200 - PN 16

**Integral seat / gear IP 68**

756 - xxxx - 104006, for DN 200-1200 – PN10  
 756 - xxxx - 114006, for DN 150-1200 – PN16

**Stainless steel seat / gear IP 68**

756 - xxxx - 10400609, for DN 200-1200 – PN10  
 756 - xxxx - 11400609, for DN 150-1200 – PN16

**Adaptor for gearbox to #25 mm:**

756-0400-2800: For DN 150 – 1200 PN10/16 mounted to IP67 gearbox or to IP68 gearbox.

**Galvanized rod #25 mm:**

To be cold drawn steel grade 37, or grade 52. Supplied by customer, not by AVK.

**Flange pipe support:**

To be supplied by customer, not by AVK, with one flange-end according to ISO 5210.

**Actuator AUMA:**

			<u>RPM</u>
AUMA SA 07.6	PN10/16	DN150-250	5,6
AUMA SA 10.2	PN10/16	DN300-400	5,6
	PN16	DN700-800	22
	PN10/16	DN900-1200	22
AUMA SA 14.2	PN10/16	DN450-600	5,6
	PN10	DN700-800	22

**ISO 5210**

F10	Open/Close torque set to 60 Nm
F10	Open/Close torque set to 100 Nm
F10	Open/Close torque set to 100 Nm
F10	Open/Close torque set to 120 Nm
F14	Open/Close torque set to 160 Nm
F14	Open/Close torque set to 150 Nm

**For all actuators please note:**

Power supply according to customer, all actuators must be supplied with connection B4 special order with inside # 25 mm (important only for this configuration). Recommended RPM are based on S15 actuators other RPM's on request.

All items marked with solid black in below illustration are included in the above configuration

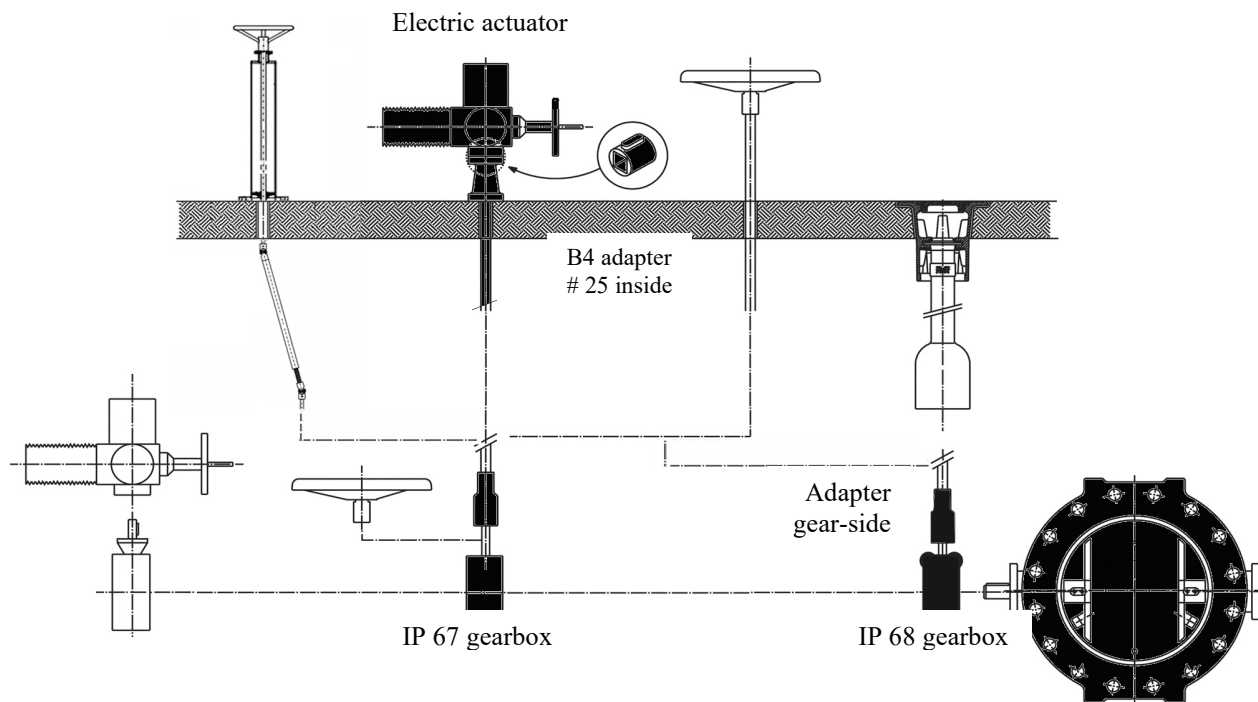

Butterfly valve DN 200-1200



This valve installation is only for ON/OFF duty.

This configuration may have a reduced lifetime compared to the configuration on page 6 as it is based on a gearbox for handwheel operation.

**Valve with ISO flange gearbox [IP67] ready for electric actuator**

Standard epox/epox PN 10/16 butterfly valve including ISO flange gearbox and operated by electric actuator. For installation in chamber, and operated by actuator directly on the valve, please order:

**Integral seat**

- 756 - xxxx - 104001, for DN 200-1200 – PN10
- 756 - xxxx - 114001, for DN 150-1200 – PN16

**Stainless steel seat**

- 756 - xxxx - 10400109, for DN 200-1200 – PN10
- 756 - xxxx - 11400109, for DN 150-1200 – PN16

**Actuator AUMA:**

DN150	PN16	AUMA SA 07.2 - F10, 5,6 RPM, Connector B4-Ø15 / keyway	Open/Close torque 20 Nm
DN200	PN10/16	AUMA SA 07.2 - F10, 5,6 RPM, Connector B4-Ø15 / keyway	Open/Close torque 25 Nm
DN250	PN10	AUMA SA 07.2 - F10, 5,6 RPM, Connector B4-Ø15 / keyway	Open/Close torque 25 Nm
DN250	PN16	AUMA SA 07.6 - F10, 5,6 RPM, Connector B4-Ø15 / keyway	Open/Close torque 45 Nm
DN300	PN10	AUMA SA 07.6 - F10, 5,6 RPM, Connector B4-Ø15 / keyway	Open/Close torque 55 Nm
DN 300	PN16	AUMA SA 07.6 - F10, 5,6 RPM, Connector B4-Ø17 / keyway	Open/Close torque 45 Nm
DN350	PN10/16	AUMA SA 07.6 - F10, 5,6 RPM Connector B4-Ø17 / keyway	Open/Close torque 50 Nm
DN 400	PN10/16	AUMA SA 07.6 - F10, 5,6 RPM, Connector B4-Ø17 / keyway	Open/Close torque 55 Nm
DN 450	PN10/16	AUMA SA 07.2 - F10, 22 RPM, Connector B3-Ø20 / keyway	Open/Close torque 20 Nm
DN 500	PN10/16	AUMA SA 07.2 - F10, 22 RPM, Connector B3-Ø20 / keyway	Open/Close torque 25 Nm
DN600	PN10/16	AUMA SA 07.6 - F10, 22 RPM, Connector B3-Ø20 / keyway	Open/Close torque 35 Nm
DN700	PN10	AUMA SA 07.6 - F10, 22 RPM, Connector B3-Ø20 / keyway	Open/Close torque 42 Nm
DN700	PN16	AUMA SA 10.2 - F10, 22 RPM, Connector B3-Ø20 / keyway	Open/Close torque 100 Nm
DN800	PN10	AUMA SA 07.6 - F10, 22 RPM, Connector B3-Ø20 / keyway	Open/Close torque 50 Nm
DN800	PN16	AUMA SA 10.2 - F10, 22 RPM, Connector B3-Ø20 / keyway	Open/Close torque 80 Nm
DN900	PN10/16	AUMA SA 10.2 - F10, 22 RPM, Connector B3-Ø20 / keyway	Open/Close torque 90 Nm
DN1000	PN10	AUMA SA 10.2 - F10, 22 RPM, Connector B3-Ø20 / keyway	Open/Close torque 100 Nm
DN1000	PN16	AUMA SA 07.6 - F10, 45 RPM, Connector B3-Ø20 / keyway	Open/Close torque 45 Nm
DN1200	PN10	AUMA SA 07.6 - F10, 45 RPM, Connector B3-Ø20 / keyway	Open/Close torque 45 Nm
DN1200	PN16	AUMA SA 10.2 - F10, 45 RPM, Connector B3-Ø20 / keyway	Open/Close torque 70 Nm

**For all actuators please note:**

Power supply according to customer, all actuators are to be supplied with connection like above (important only for this configuration).

Recommended RPM are based on S15 actuators other RPM's on request.

All items marked with solid black in below illustration are included in the above configuration

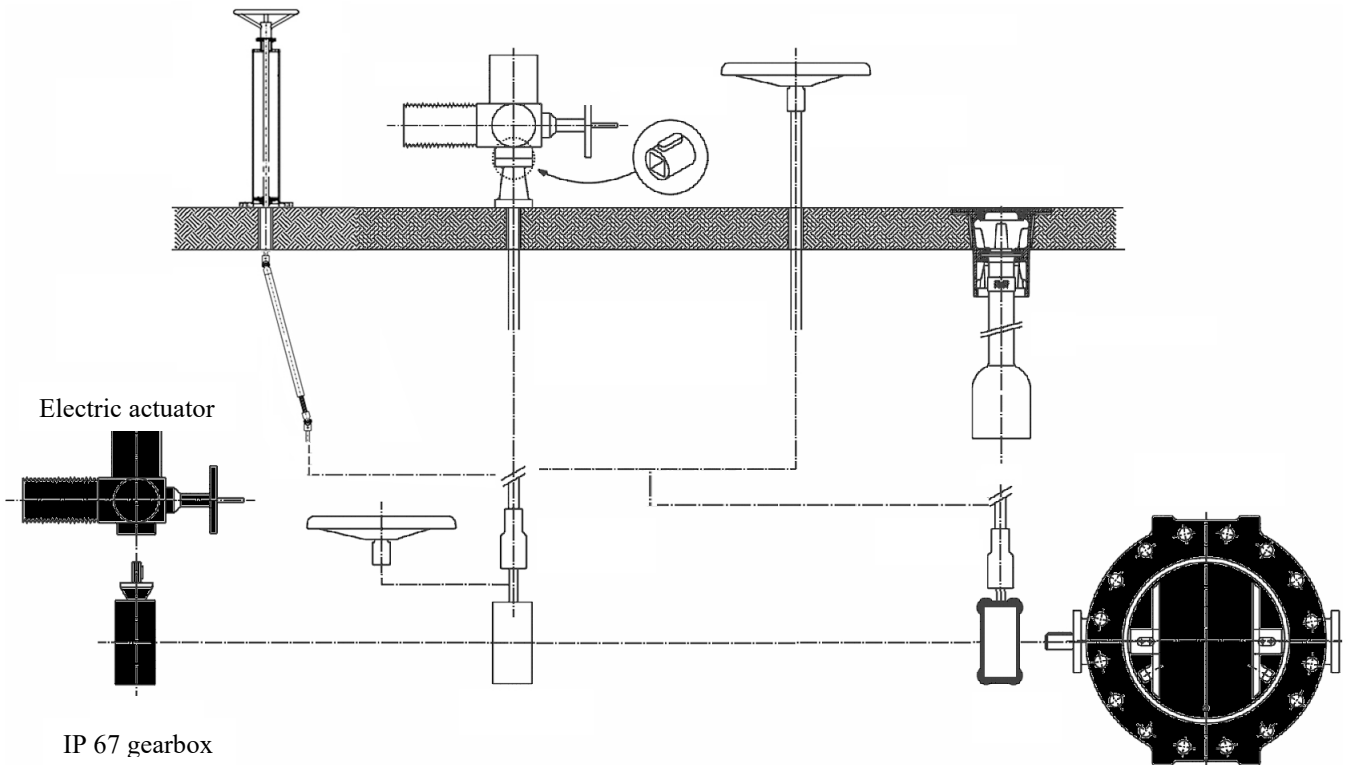

This valve installation is only for ON/OFF duty.

**Valve with gearbox [IP 67 or IP 68] and headstock**

Standard epox/epox PN 10/16 butterfly valve including gearbox, extension carried out with steel bar #25 mm supplied by customer and operated by headstock with flexible joint. For installation in chamber or underground by headstock above ground, please order:

**Integral seat / gear IP67**

756 - xxxx - 104, for DN 200-1200 - PN 10  
 756 - xxxx - 114, for DN 150-1200 - PN16

**Stainless steel seat / gear IP67**

756 - xxxx - 10400009 for DN 200-1200 - PN 10  
 756 - xxxx - 11400009 for DN 150-1200 - PN 16

**Integral seat / gear IP 68**

756 - xxxx - 104006, for DN 200-1200 - PN10  
 756 - xxxx - 114006, for DN 150-1200 - PN16

**Stainless steel seat / gear IP 68**

756 - xxxx - 10400609, for DN 200-1200 - PN10  
 756 - xxxx - 11400609, for DN 150-1200 - PN16

**Adaptor for gearbox to #25 mm:**

756-0400-2800: For DN 150 – 1200 PN10/16 mounted to IP67gearbox or to IP68 gearbox.

**Headstock with flexible joint:**

Pricing and sizes on request.

Instead of a handwheel, an electric actuator can be fitted.

When requiring prices, please specify the following

- Distance between centreline of valve shaft to top floor level (the flex joint is extendable)
- Handwheel or actuator – standard is handwheel

-----  
 All items marked with solid black in below illustration are included in the above configuration

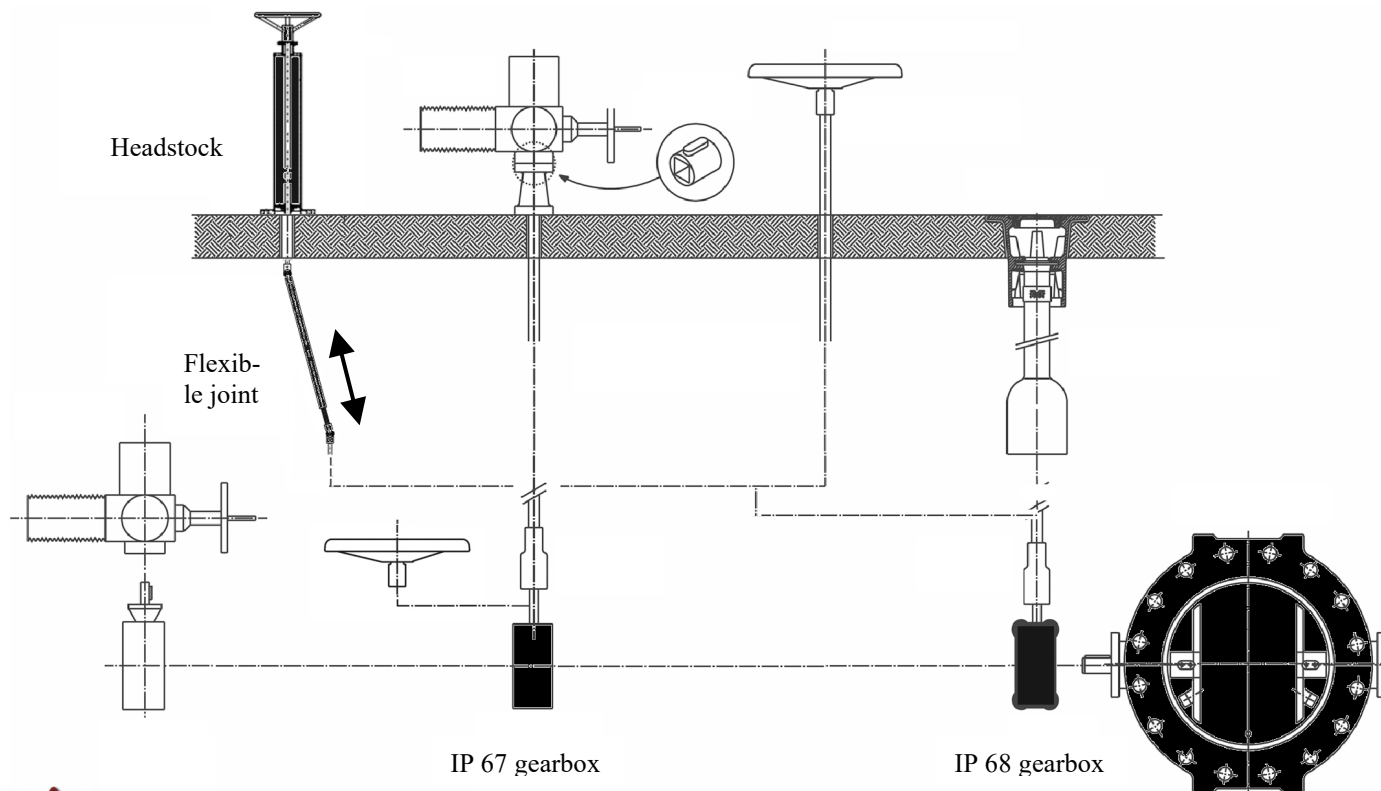

This valve installation is only for ON/OFF duty.

Butterfly valve DN 150 - 1200